

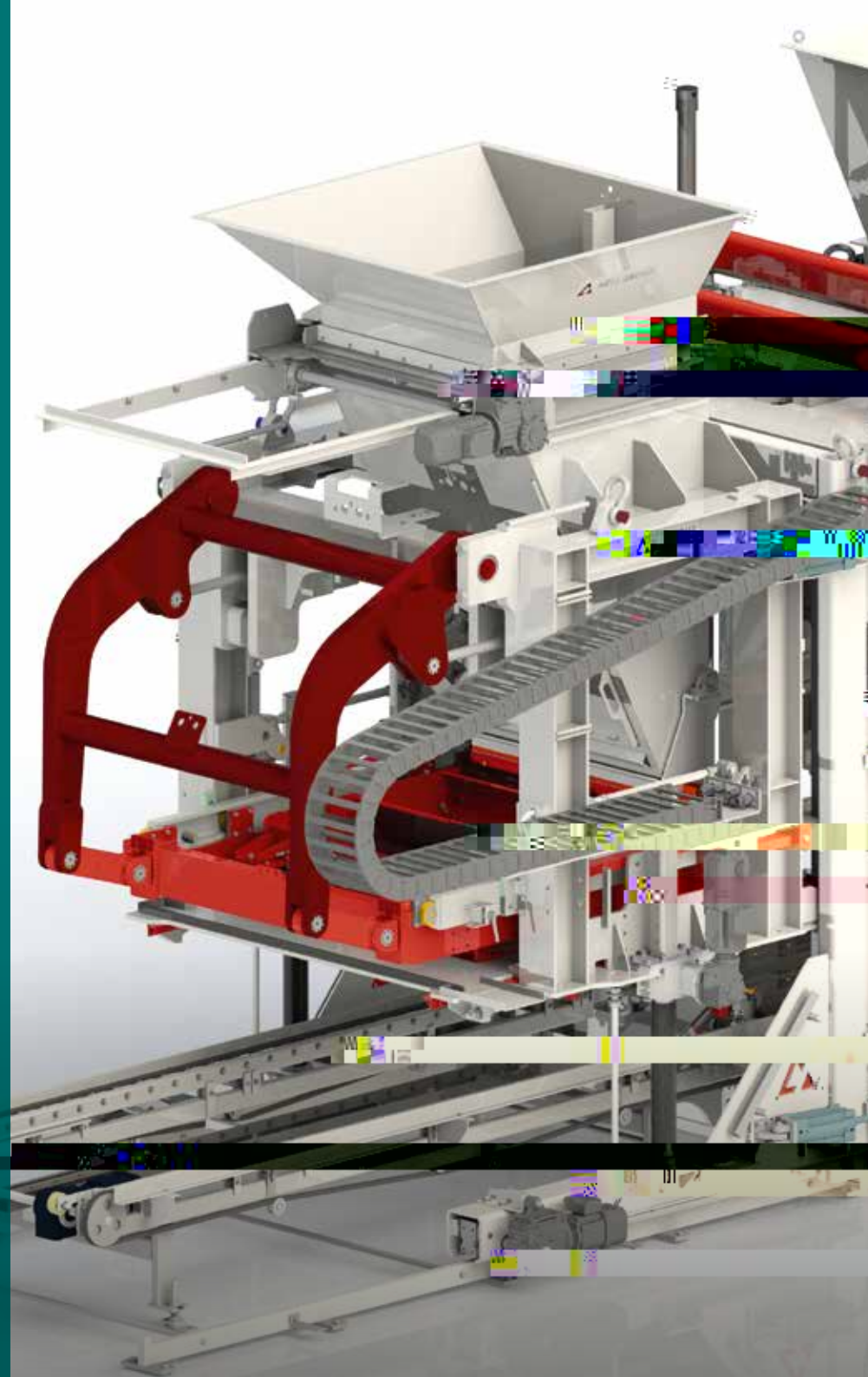

HESS GROUP

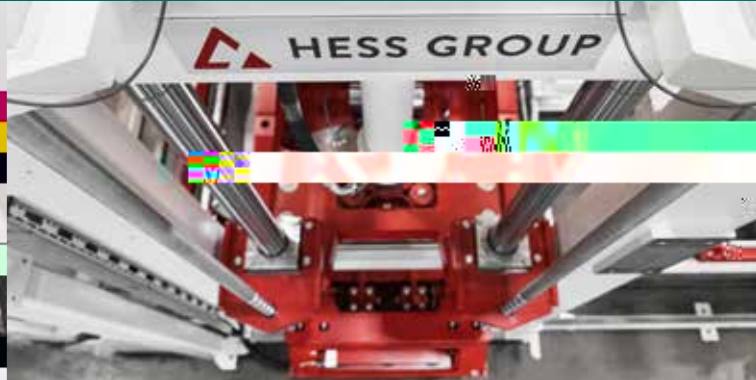

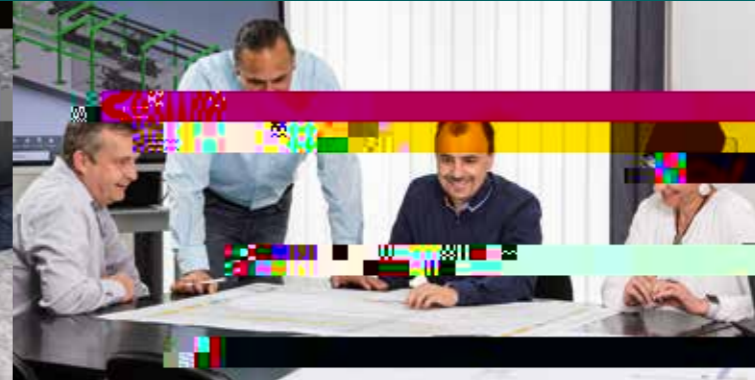

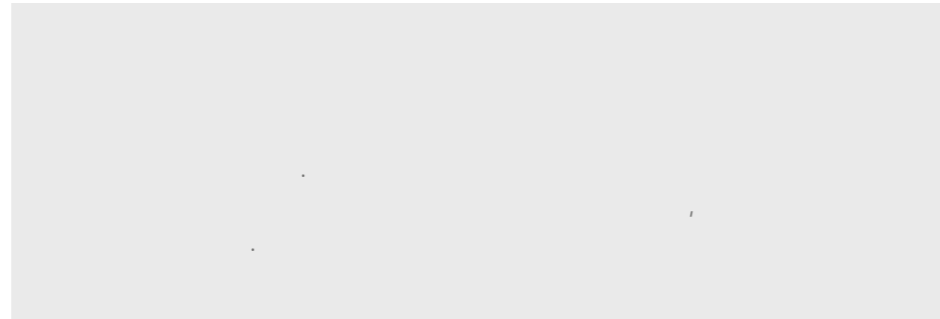
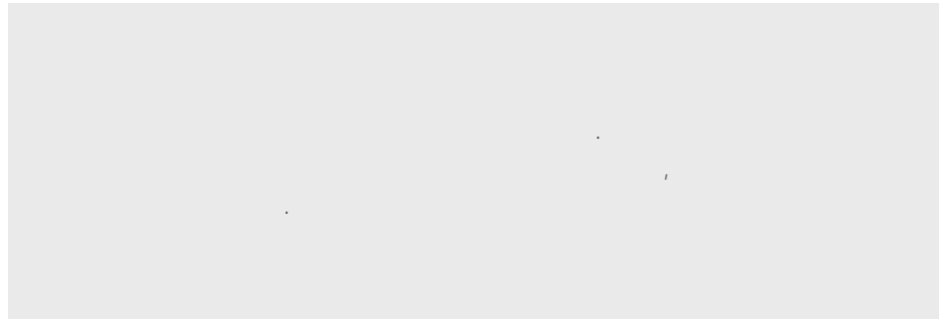
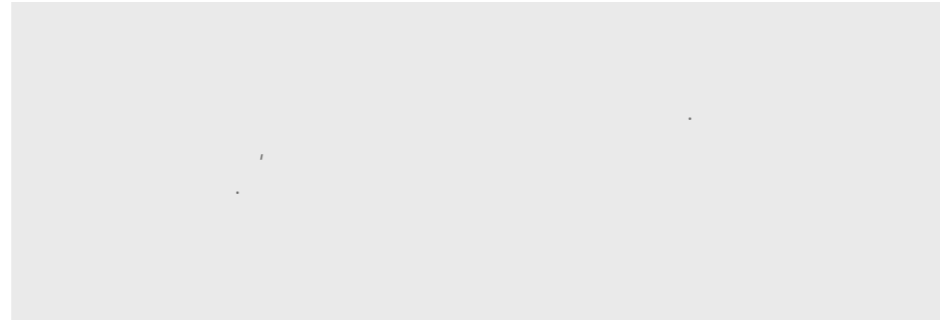
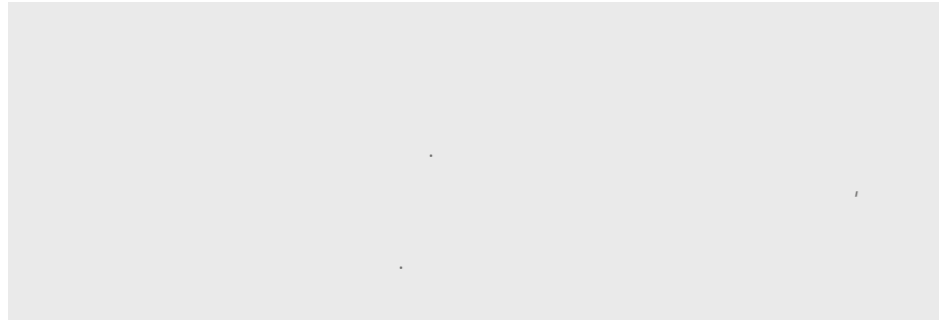
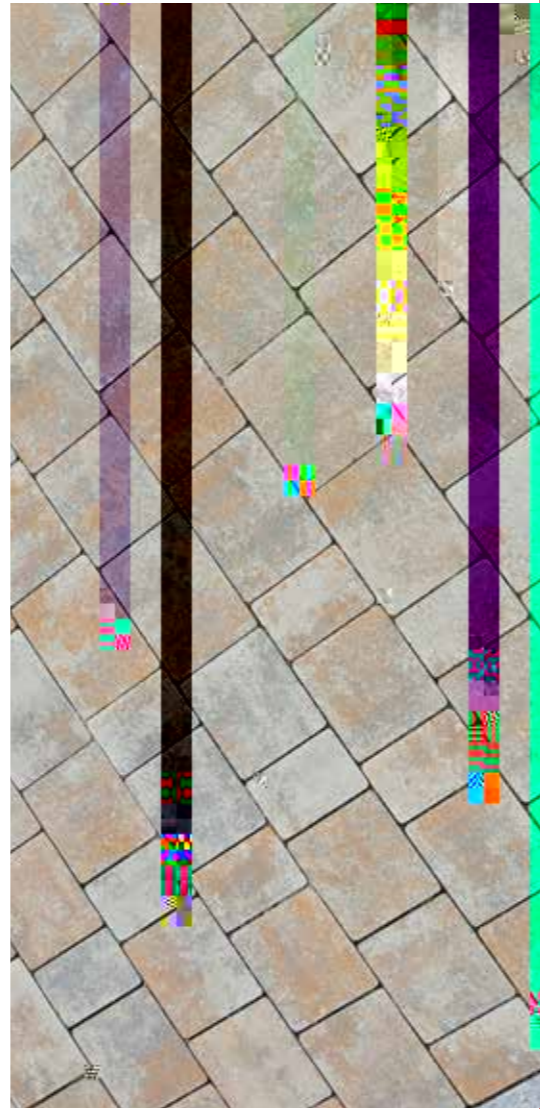
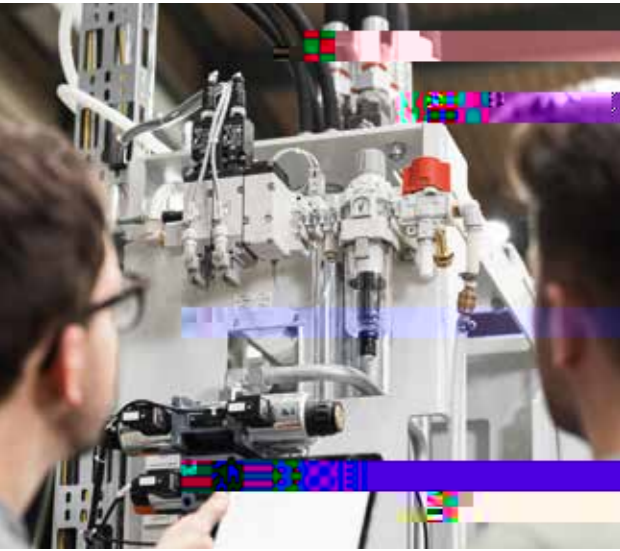

RH 1450



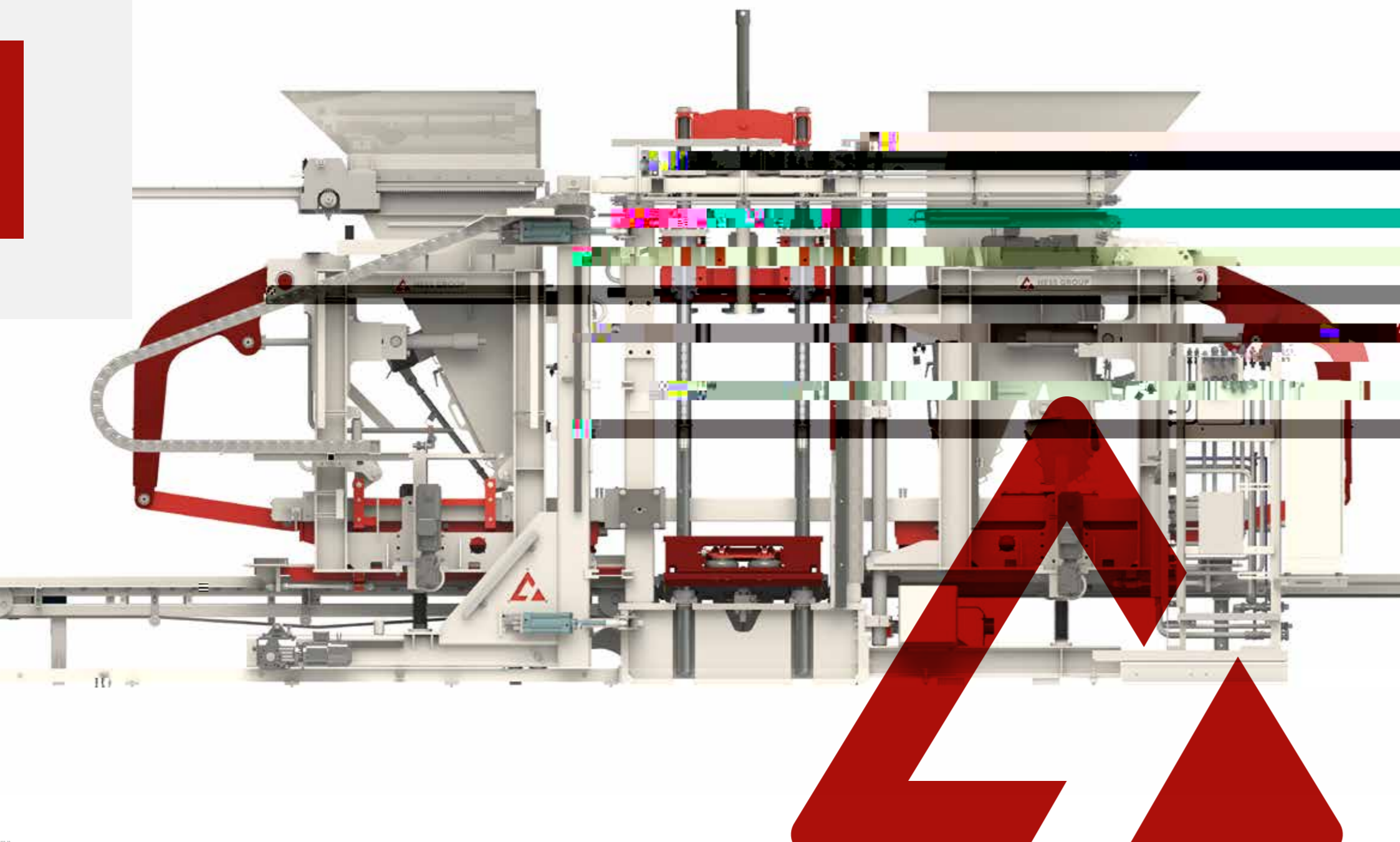

RH 1450

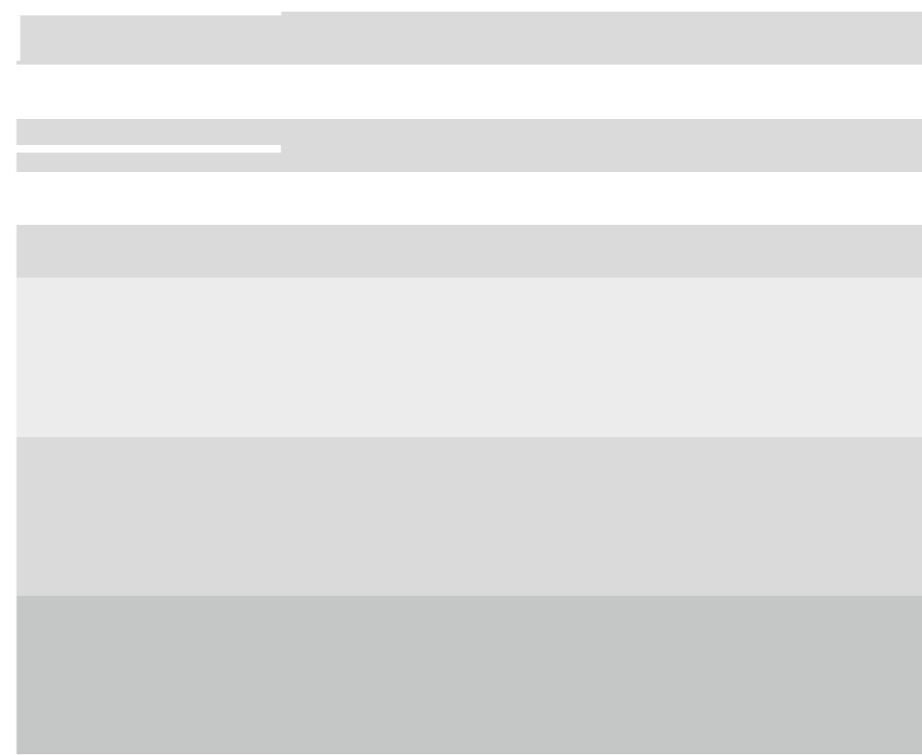

85%

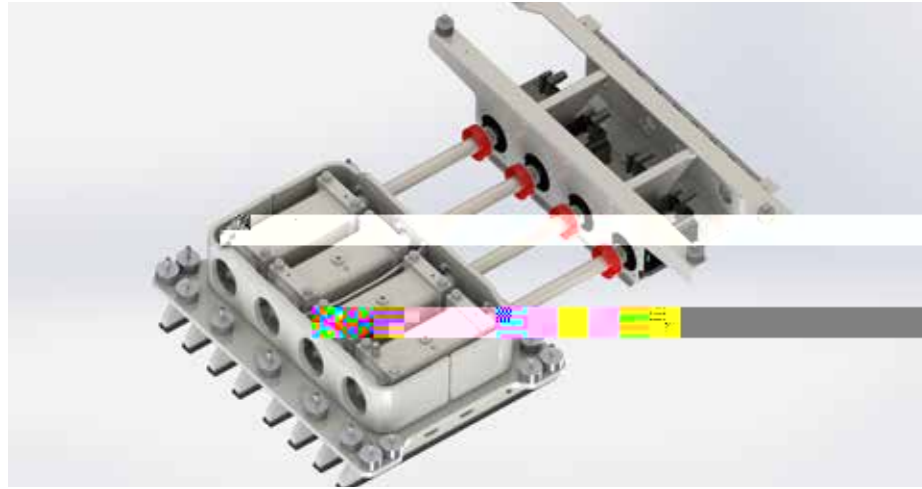
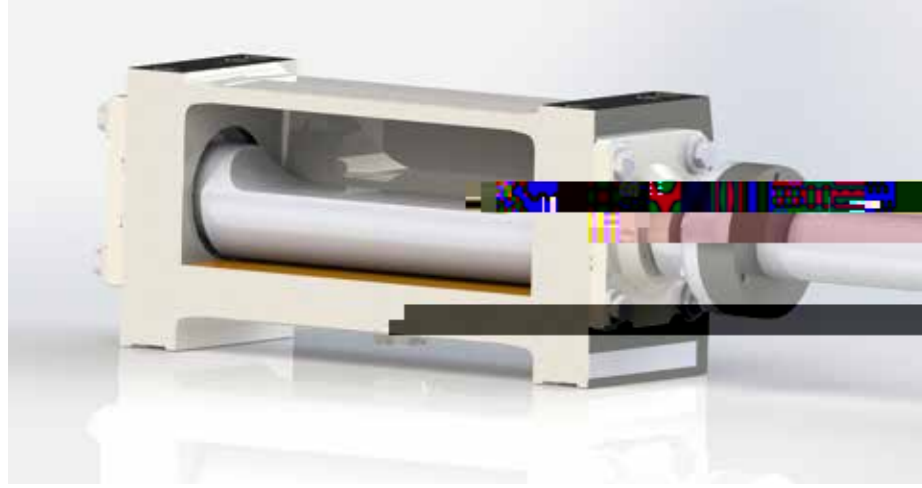

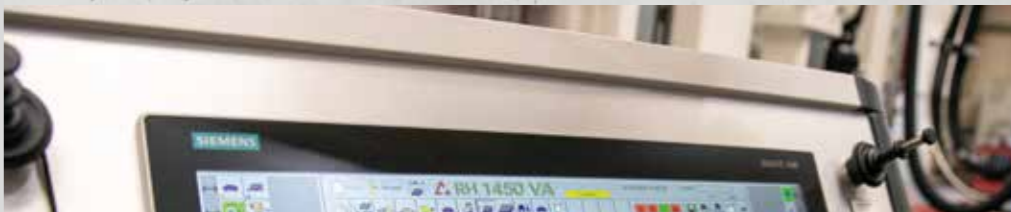

HESS



ЕЛ



Hess

HESS

-
-
-
-

RFID-

| | | | | | | | |
|---------|----------------|-------------|-------------|---------------|---------------|---------------|-----------------------------|
| | []** | 1.200 x 670 | 1.400 x 700 | 1.400 x 1.100 | 1.400 x 1.100 | 1.400 x 1.100 | 1.400 x 1.300 |
| | [] | 1.100 x 620 | - | 1.300 x 1.050 | 1.300 x 1.050 | 1.300 x 1.050 | 1.300 x 1.250 |
| | [] | 25 | 25 | 40 | 25 | 25 | 25 |
| | [] | 300 | 300 | 500 | 500 | 500 | 500 |
| | VA [] | 7.700 | 14.000 | 38.000 | 46.000 | 46.000 | 48.000 |
| 10x20x5 | [] | 17 | 14 | 12,5 | 10,5 | 10 | 10 |
| | ² 8 | 863 | 1.258 | 2.114 | 2.517 | 2.644 | 3.230 |
| | 14 | 12,5 | 0,5 | 863 | 1.258 | 2,11 | 10,5 |
| | | | | | | 5 46 | 3.258, 25 |
| | | | | | | | M ³ 4 0,51,32 25 |
| | | | | | | | |
| | | | | | | | |
| | | | | | | | |

| | | | |
|--|--|--|--|
| | | | |
|--|--|--|--|

| | | | |
|--|--|--|--|
| | | | |
|--|--|--|--|

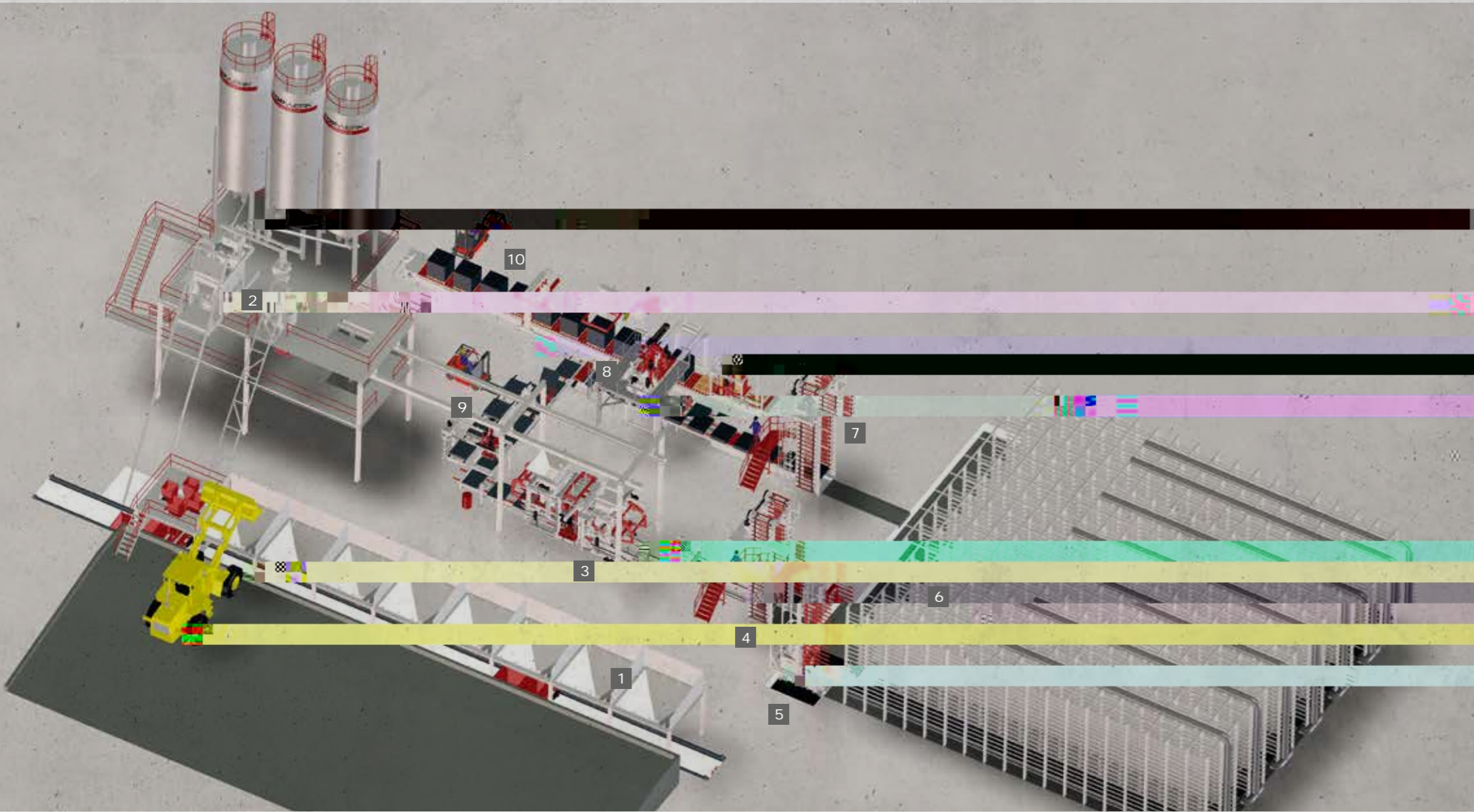

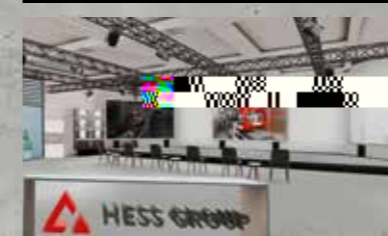
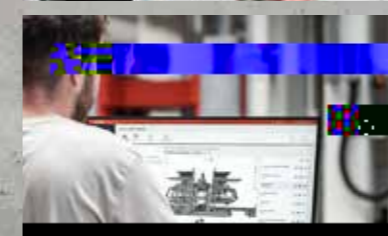
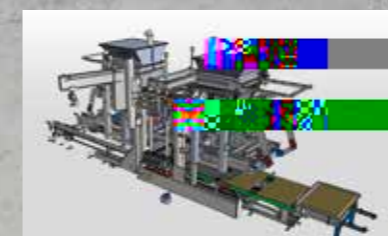
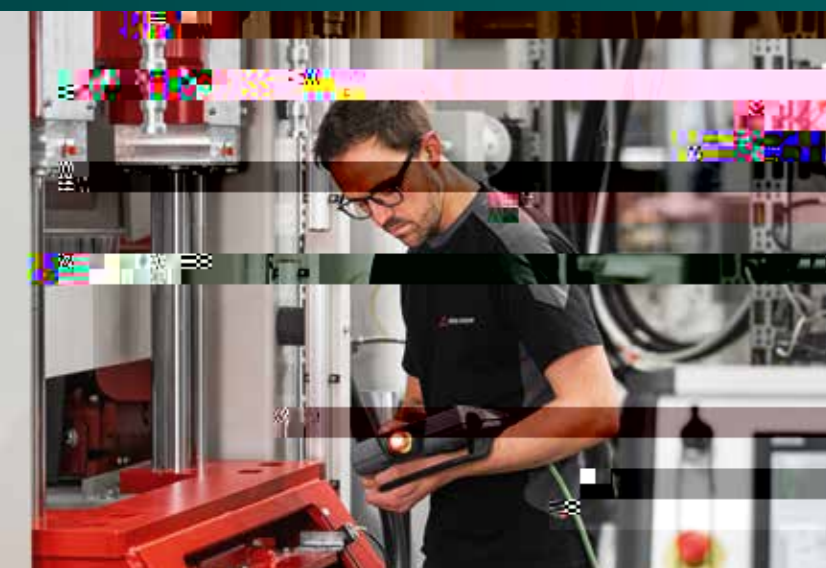



Freier-Grund-Straße 123
57299 Burbach-Wahlbach,

: +49 2736 4976 0

: info@hessgroup.com

www.hessgroup.com